

X-Light V3

Spinning disk confocal



SEE BRIGHTER , SEE FASTER , SEE MORE

X-Light V3 is the next generation of spinning disk. It relies on the cutting-edge technology, advanced optical design and engineering solutions developed by CrestOptics to meet the very high-end specifications required by modern fluorescence microscopy applications.

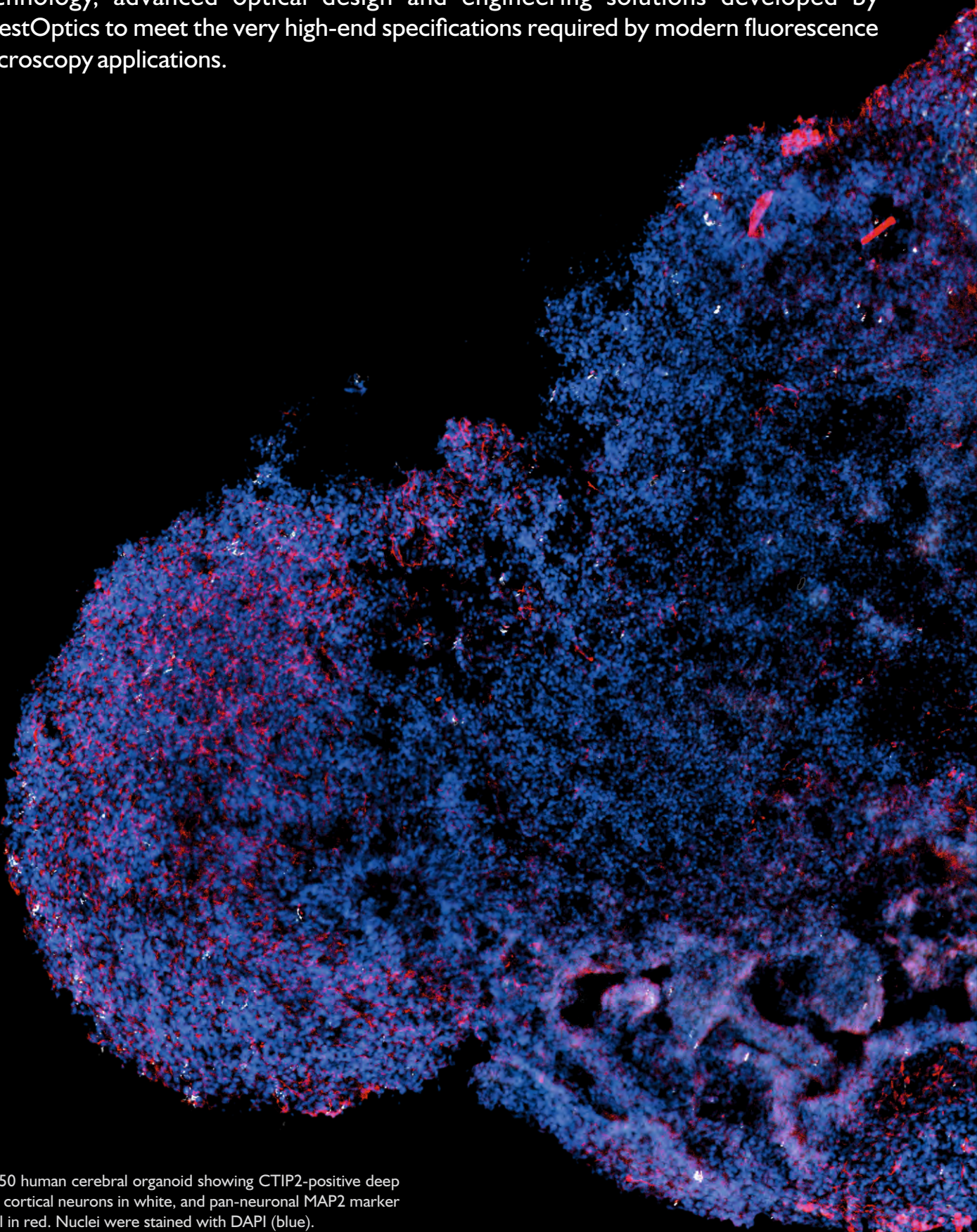

Day 50 human cerebral organoid showing CTIP2-positive deep layer cortical neurons in white, and pan-neuronal MAP2 marker signal in red. Nuclei were stained with DAPI (blue).

500 μm



SEE BRIGHTER



Enhanced
Sensitivity and
image quality

The disk optimized geometry together with the carefully designed optical layout gives contrast and image clarity, ensuring **brighter images of dim samples.**

SEE FASTER



High-
sectioning,
Hi-speed

The capacity to image a field of view up to 25mm at the maximum disk rotation, makes the X-Light V3 **the fastest confocal microscope on the market.**

SEE MORE

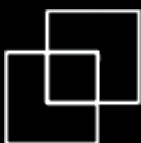

Dual-camera
ultra-large
field of view

It is also the first confocal unit that allows **dual camera imaging of the full field of view on both cameras with homogenous illumination.**

Multiple modalities

The X-light V3 is designed to be a truly enabling technology where performance is combined with the flexibility of a modular, expandable system. To achieve this, the CrestOptics X-light V3 has **three modes of use**:

The motorized IN/OUT disk allows for a fluid widefield/confocal transition without the need for realignment.

WIDEFIELD

With the X-light V3 every upright or inverted microscope can benefit from confocal's advanced optical sectioning capacity.

SPINNING DISK
CONFOCAL

The system is designed to be compatible with the DeepSIM add-on, for a seamless evolution from confocal to super-resolution.

SUPER-RESOLUTION

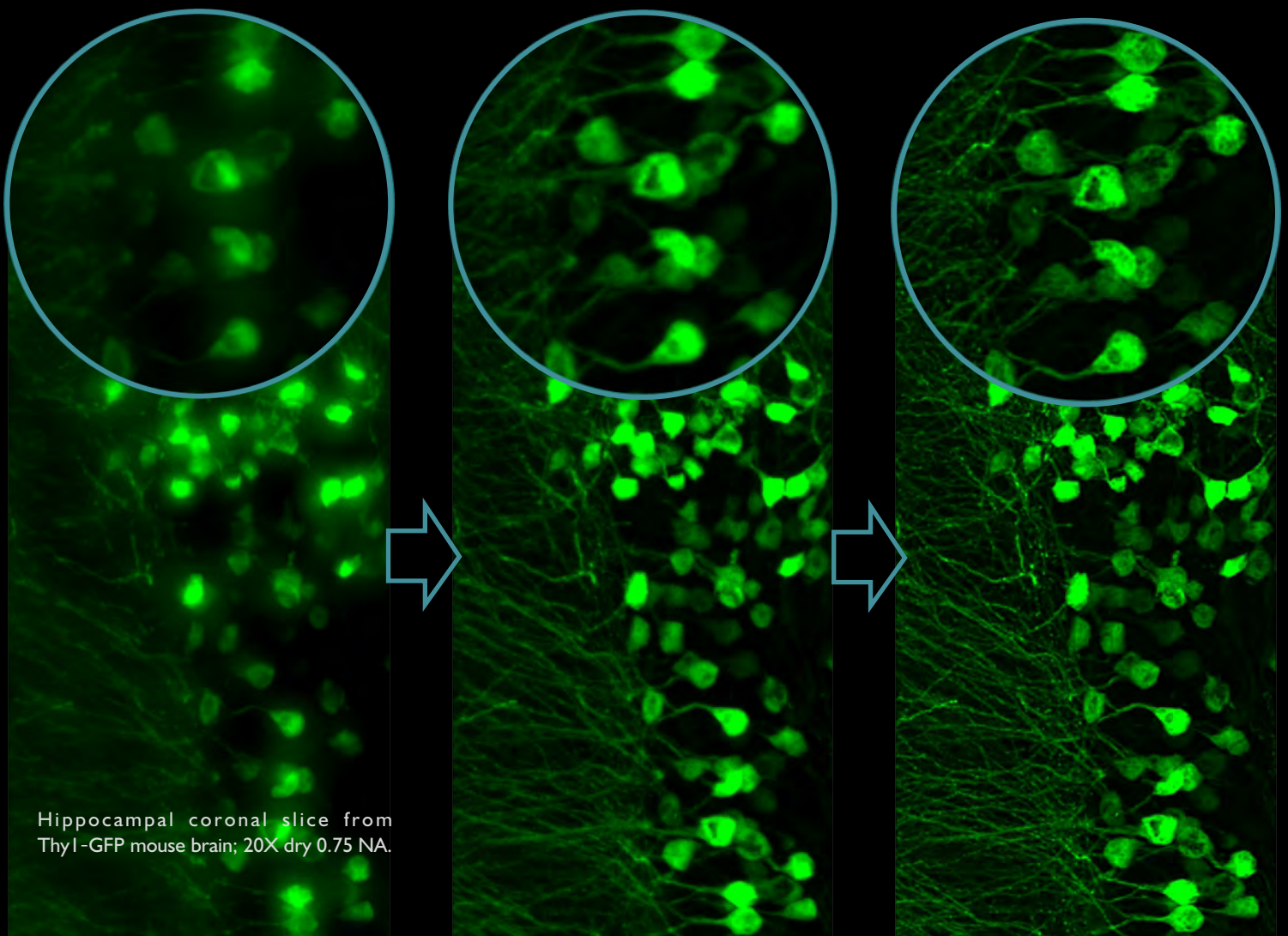

Hippocampal coronal slice from
Thy1-GFP mouse brain; 20X dry 0.75 NA.

Largest FOV in the market

X-light V3

traditional SDCM

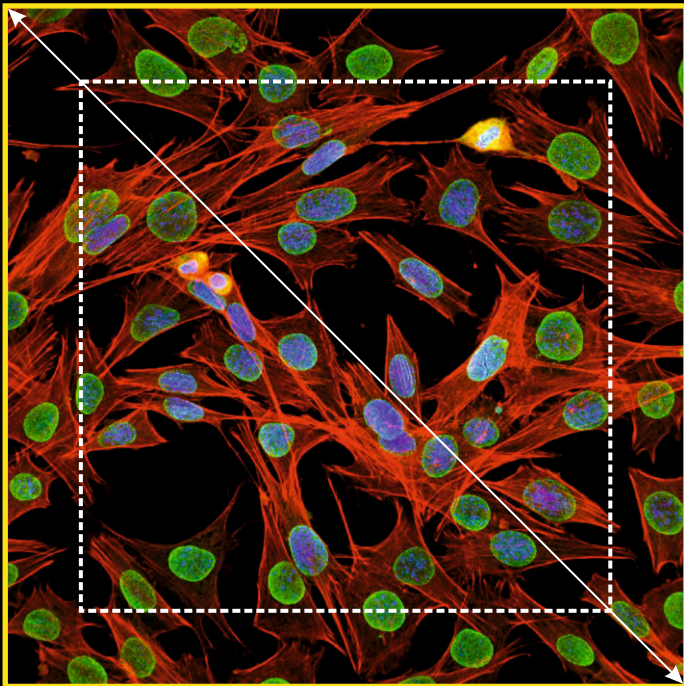

Lung cells, DAPI for DNA (blue), laminin in green, F-actin in red, CFI Plan Apo Lambda 60X oil, 1.4 NA.

New scientific discoveries often depend on imaging and analyzing large populations of cells to obtain robust data.

With the **largest field-of-view (FOV)** for both inverted and upright microscopes (25 mm diagonal), more specimens fit in one FOV with more objective lens choices than ever before.

Biology in 3D involves more than monolayers of cells; the X-light V3 is designed to capture spheroids and full organisms in a single FOV.

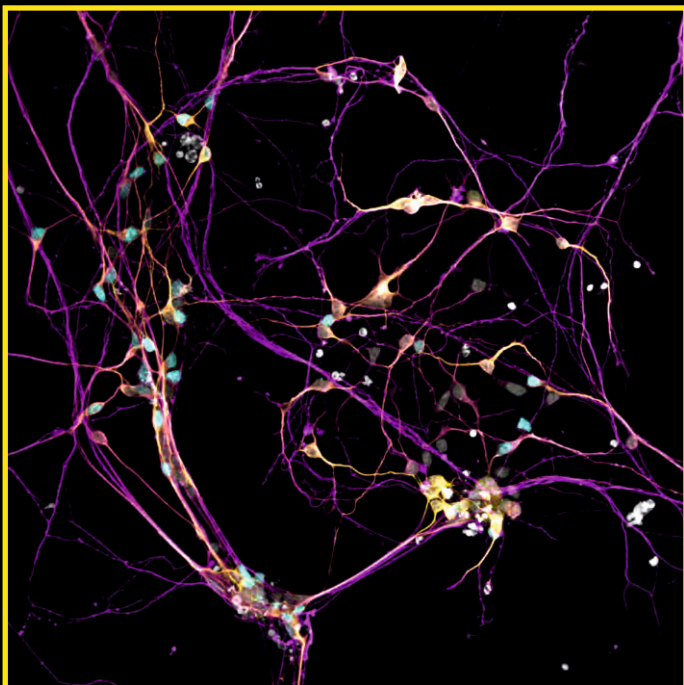

Retinal ganglion cells, DAPI for DNA (white) and three differentiation markers, MAP2 (yellow), Tuj1 (magenta), Brn3a (cyan). 40x water objective, NA 1.25

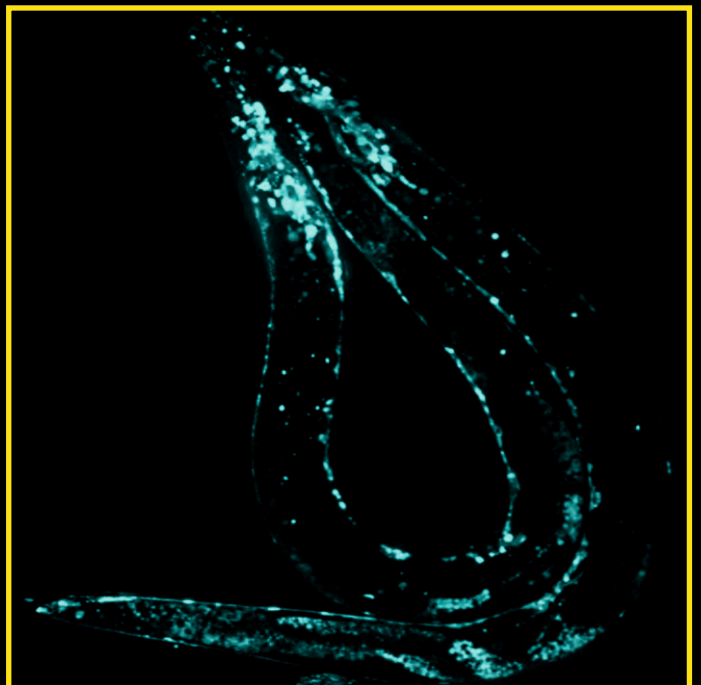

Nematodes expressing a pan-neuronal genetically encoded fluorescent Ca²⁺ indicator, 25X SIL 1.05 NA objective.

Largest FOV in the market

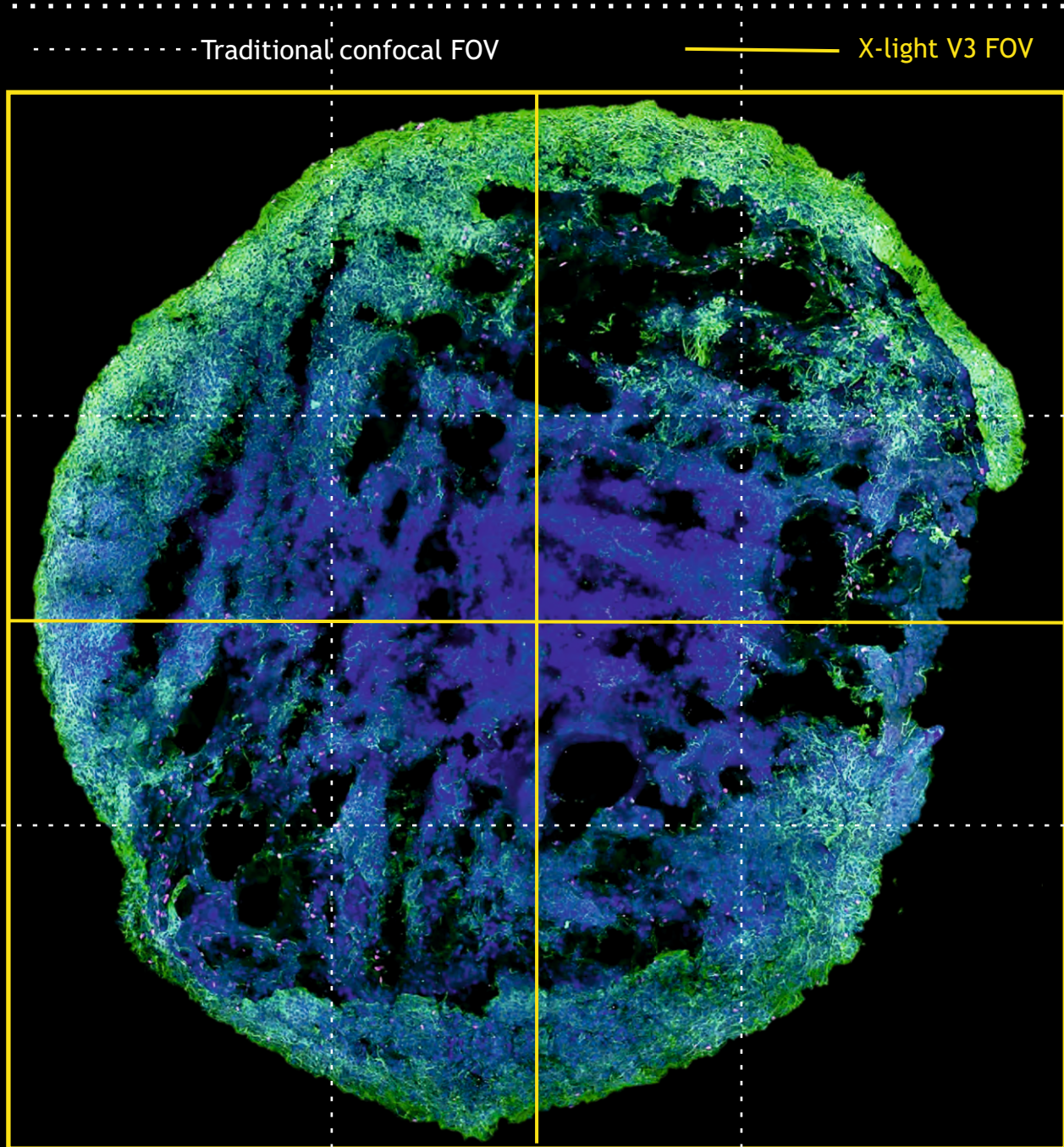

Brain organoid, stitched image: nuclear transcription factor TBR1 (Alexa 750 fluorophore, shown in magenta), microtubule-associated protein MAP2 (Alexa 488 fluorophore, shown in green), DAPI for DNA in blue. Plan Apochromat Lambda 60X oil, 1.45 NA.

The wider FOV allows the imaging of a sample area almost double the size of conventional imaging systems. A wider area translates into more information collected from each image and a reduction in the number of tiles needed to cover a large sample, significantly **accelerating the research process**. Further acceleration is provided by the dual-camera functionality.

Uniform illumination for data quantification

Homogeneous illumination over the entire field of view is essential for quantitative imaging. The X-light V3 illuminator is based on **micro-lens technology** which is able to turn a high-power laser from a multi-mode fiber into a uniform square collimated beam with over 90% homogenous illumination over the entire 25mm FOV. This unique feature allows **data quality and data throughput to be increased** avoiding artifacts and recovering information even from the periphery.

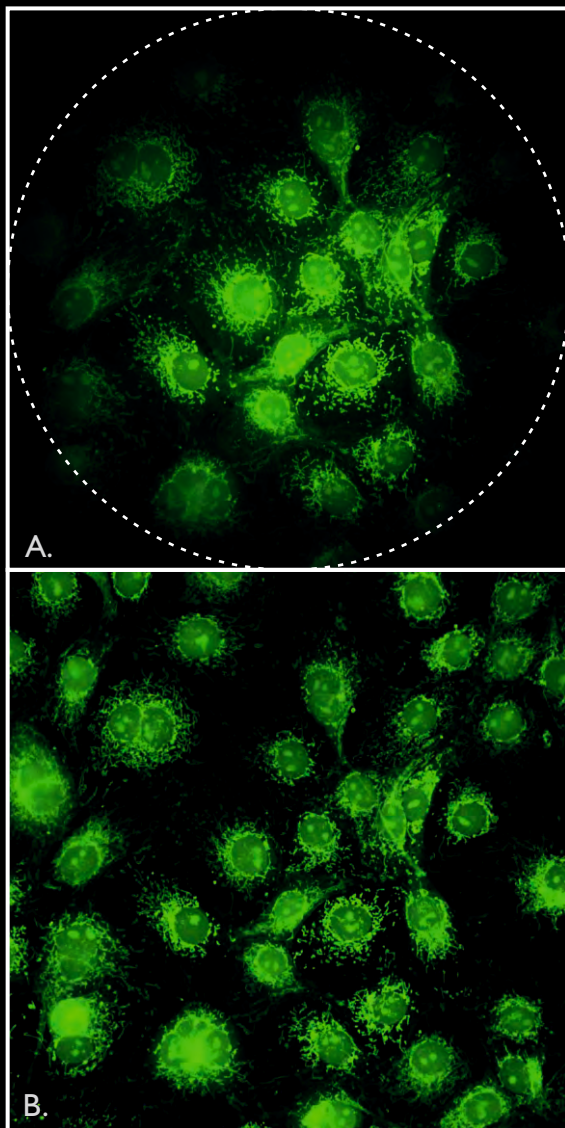

Cos-7 cells with mitochondria in green (Anti-Tom20 with OG 488). (A) Illumination without micro-lenses. (B) FOV illumination with micro-lenses. Objective 60X oil, 1.4 NA

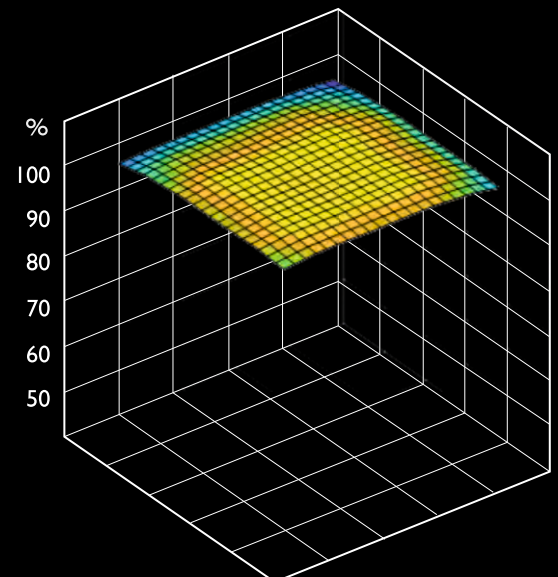
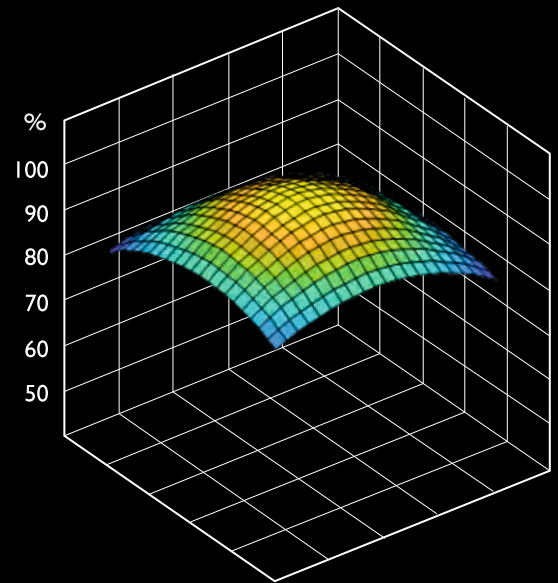

Power distribution over the FOV with CrestOptics micro-lenses illuminator

Seamless stitching of large samples

Combined with the 25mm FOV, micro lenses are essential for **seamless stitching of images of large samples** like tissues, organoids and full organisms. This ability allows you to:

- get reliable data without artifacts, avoiding any post-processing correction
- reduce photobleaching and increase speed by minimizing the overlap of tiles
- increase data throughput and guarantee data quality

**Traditional
illuminator**

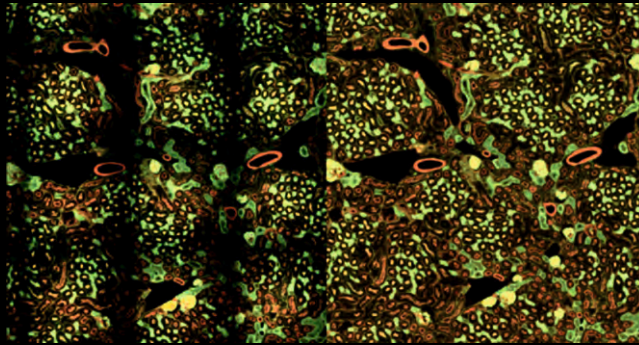

**X-light V3
Micro-lenses
illuminator**

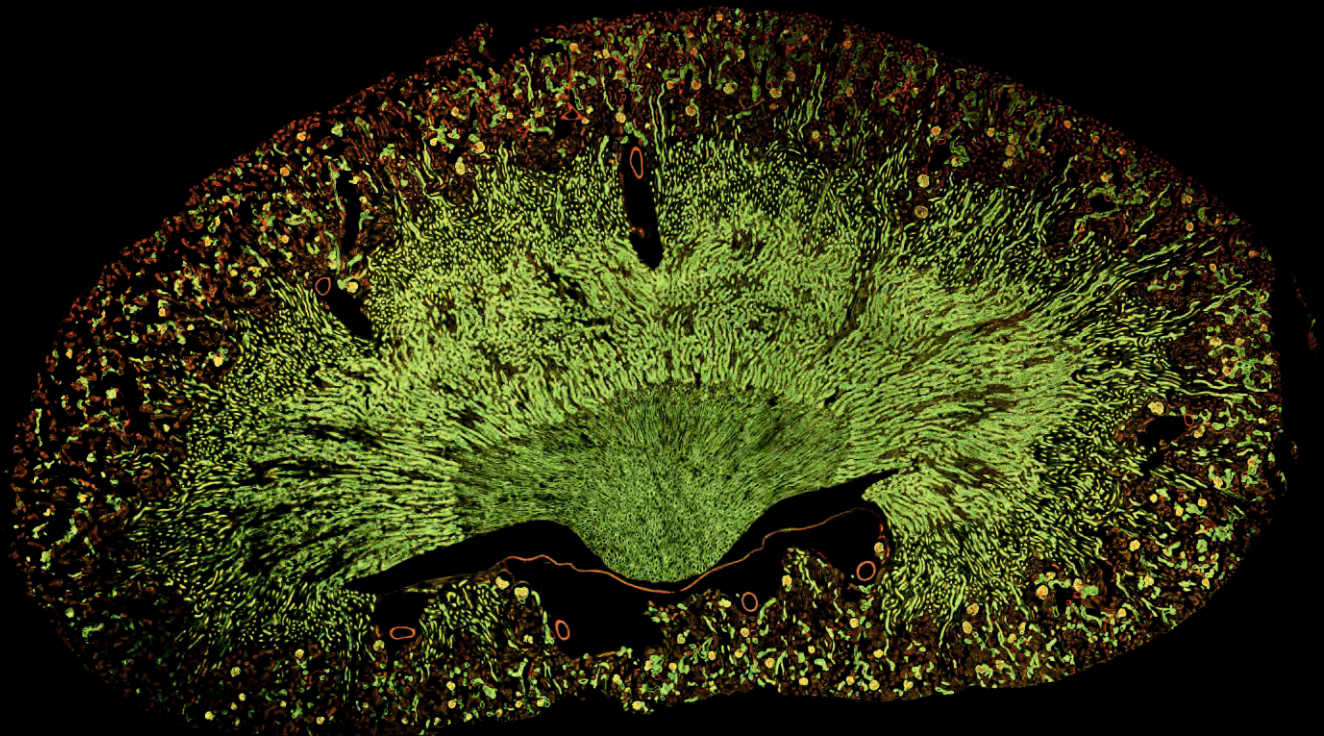

Seamless stitching of mouse kidney tissue section with Alexa 488 WGA, Alexa 568 Phalloidin

Tailor made solutions

The spinning disk-box is one of the most versatile components of the X-light V3. CrestOptics offers the **freedom to choose the disk geometry that best suits your applications**, including complete disk customization. The 50 μm diameter spinning disk is available in three different versions:

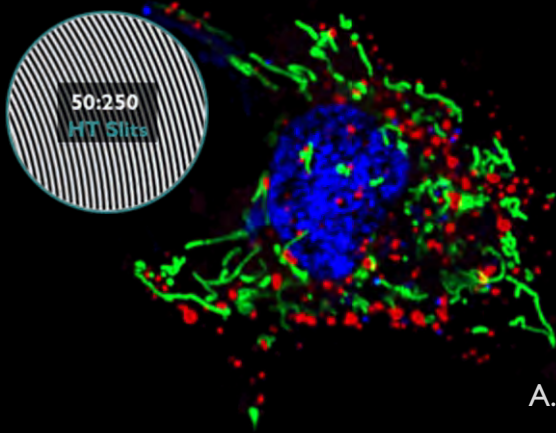

Multicolor live cell imaging

High Throughput (HT) Slits geometry is designed for samples that require **high speed and low excitation power**.

Cell monolayers and thin tissue imaging

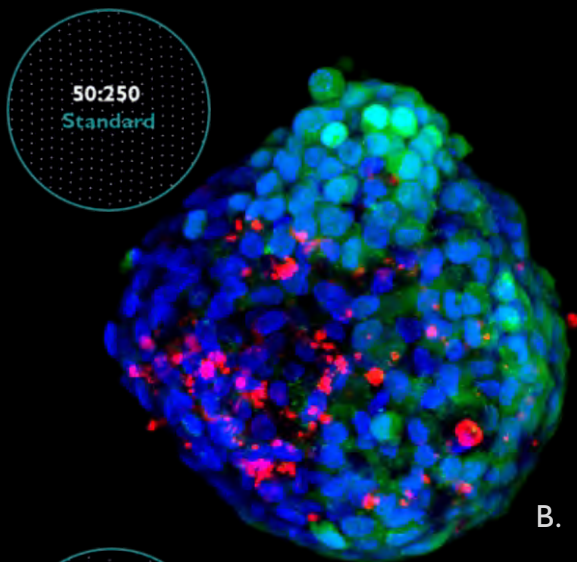

3D samples greater than 30 μm thick

The standard disk is the **ideal balance between brightness and confocality** for a wide range of applications during routine research.

Clarified tissues

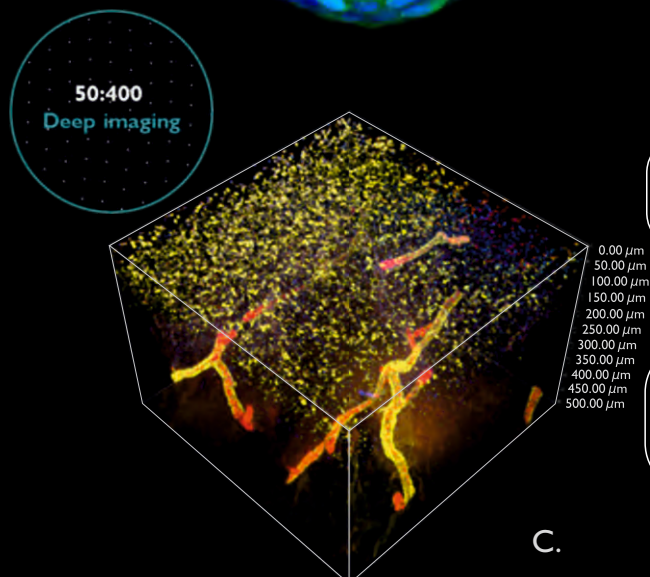

Deep imaging over 200 μm

The wider spacing version has been designed to further enhance the **image quality and sectioning in thicker specimens** thanks to the large reduction of crosstalk between pinholes.

High density and high scattering samples

A. *see zoom description on the following page B. MIP from Z stack of a cancer spheroid, living cells are marked with Calcein (green), dead cells with PI (red), nuclei are stained with Hoechst (blue). 25X SIL 1.05 NA objective. C. Clarified mammary gland tissue, 3D volume view 500 μm thick, showing keratine 8 (red) keratine 5 (yellow) and DAPI (blue). 25X SIL 1.05 NA objective.

Dual color, fast imaging, still wider

A crucial issue in imaging live samples is the ability to localize small multicolor fluorescent signals and track them while moving at high speed. With the highest spinning disk rotation on the market (15K rpm), the X-light V3 offers an **achievable speed of over 1000fps on full FOV**, over 10-time faster acquisition compared to the fastest point scanning confocal.

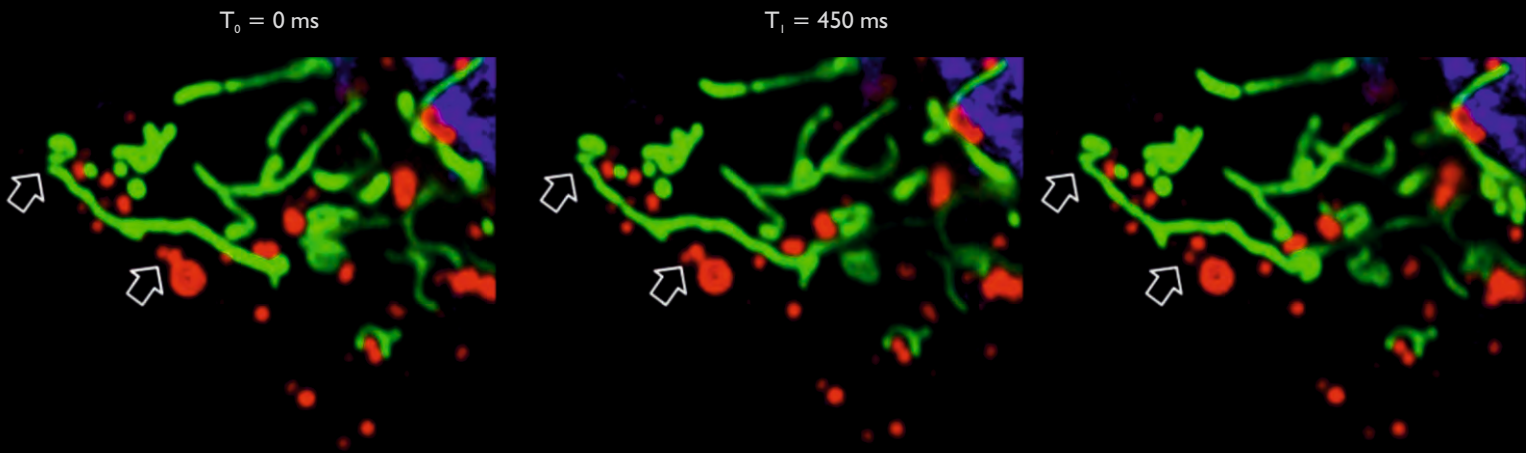

*Multicolor fast live cell imaging, nuclei in blue [Hoechst], mitochondria in green [mito-EGFP], endosomes in red [tagRFP-EEA1]. Arrows indicate highly dynamic events like mitochondria fusion and endosomes trafficking. Scan the QR code to watch the full video.



Thanks to the default **dual-camera configuration**, the X-light V3 allows you to run **simultaneous multi-color imaging** on a FOV of 25mm on both cameras.

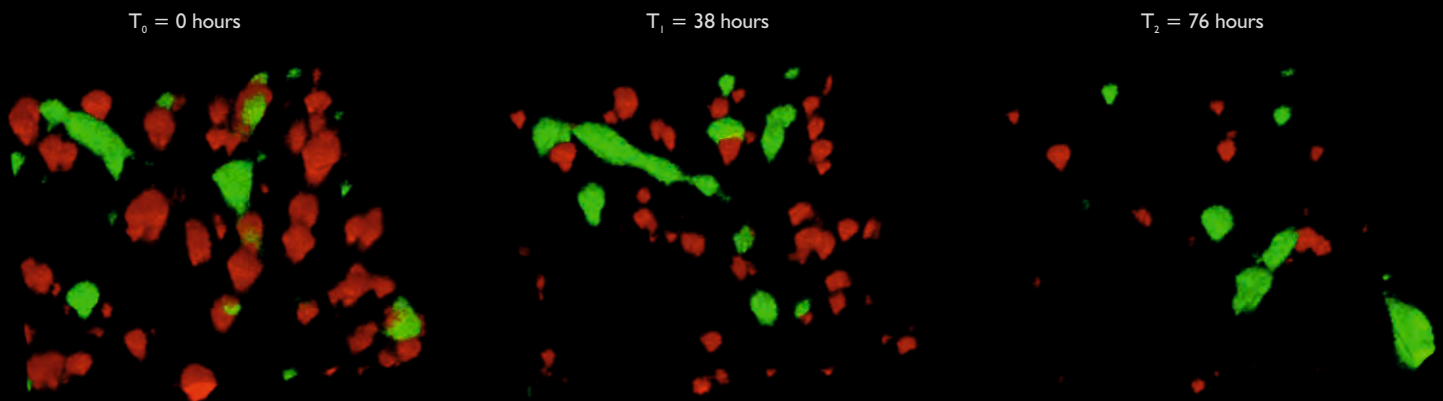

Tumor target A673 cells are shown in red and AD-MSCs TRAIL in green. Three frames extracted from 72 hours long-term live cell imaging acquired with 4x dry Plan Apo objective 0.2 NA, Z volume of 500 μ m. Scan the QR code to watch the full video.



Configurations

Inverted

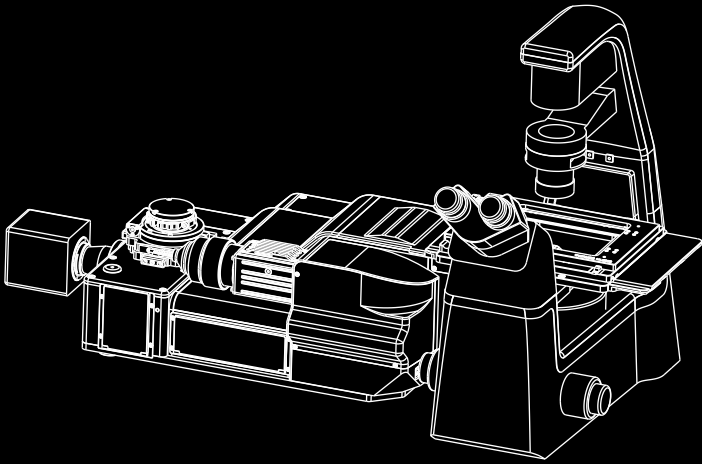

Upright

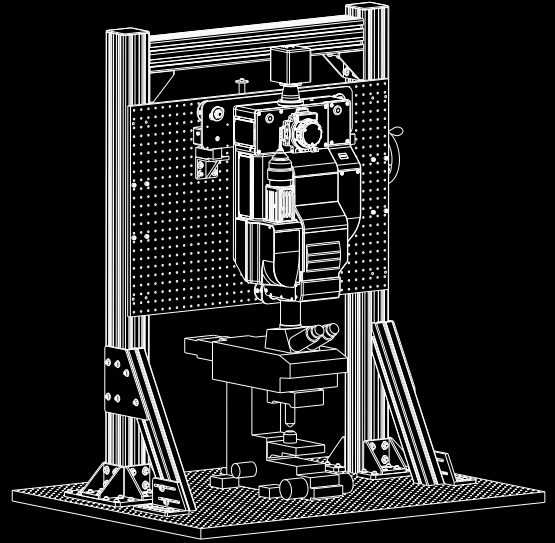

Layout

X-light V3 spinning disk

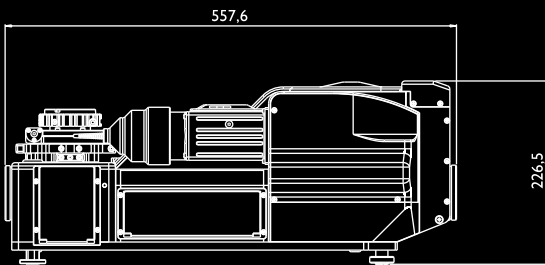

X-light V3 combined with the DeepSIM super-resolution

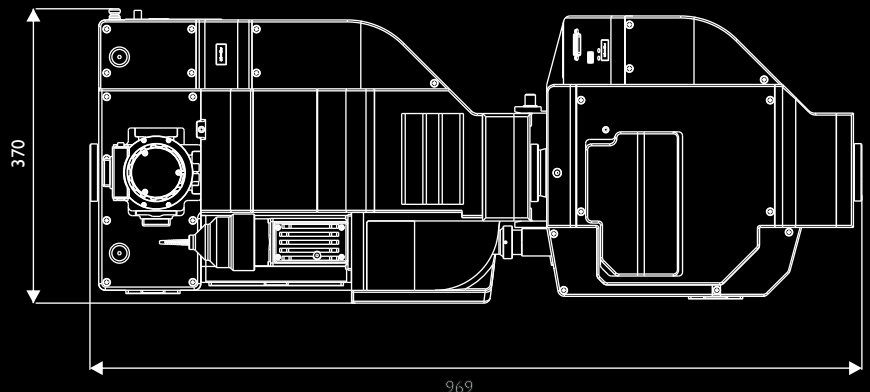
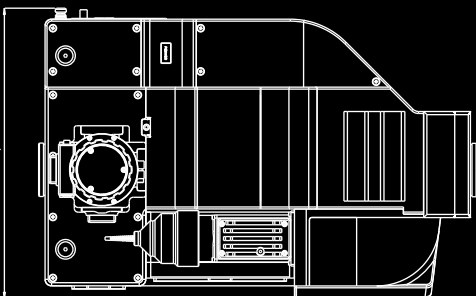
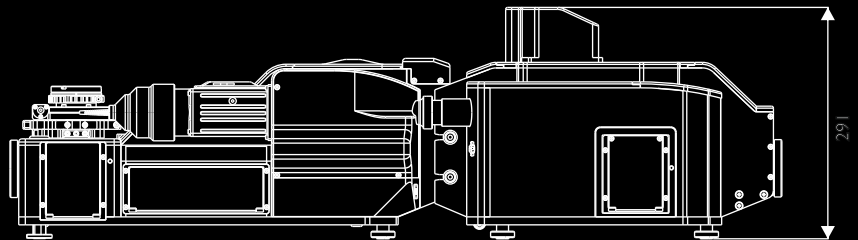

Specifications

Imaging modalities	Widefield / Confocal / Super-resolution (in combination with DeepSIM SR add-on module)
Compatible microscopes	Full range of upright and inverted microscopes
FOV	Up to 25mm diameter
Laser	Multi mode lasers with SMA coupling
Spectral range	Excitation 400-750 nm / Emission 400-850 nm
Camera	Compatible with CCD/EMCCD cameras and sCMOS cameras Dual-camera view: simultaneous dual-camera imaging up to 25 mm
Disk speed/scan rate	15000 RPM / > 1000 fps
Spinning disk geometry (diamater/spacing)	50/250 slit spirals for high throughput applications 50/250 μm pinholes for routine imaging 50/400 μm with wider spacing for deep imaging
Resolution	Lateral Resolution (FWHM): ~ 230 nm (High NA 1.4) Axial Resolution (FWHM): ~ 600 nm (High NA 1.4)
Filter wheels	Motorized filter wheels and slider: 4-positions cleanup filter wheel, 3-positions dichroic filter wheel, 8-positions emission filter wheel, 3 positions slider for dual camera use
Software	Nikon NIS-Elements / Micro-Manager / MetaMorph / Volocity / VisiView
Recommended Installation Conditions	Temperature 23 ± 5 °C, Humidity 70% RH or less (no condensation)
Weight	26.0 Kg (57 lbs)
Dimensions	14 (w) x 23.9 (L) x 8.9 (h) inches 357.0 (w) x 606.0 (L) x 225.0 (h) mm

Specifications and equipment are subject to change without any notice or obligation on the part of the manufacturer. October 2021 ©2021 CrestOptics S.p.A.



WARNING

TO ENSURE CORRECT USAGE, READ THE CORRESPONDING MANUALS CAREFULLY BEFORE USING YOUR EQUIPMENT.



CrestOptics S.p.A.
Via di Torre Rossa 66, 00165, Roma (RM)
www.crestoptics.com
Tel. +39 06 6147496